

EasyControl
Art. 1881

- D Betriebsanleitung**
Bewässerungscomputer

- F Mode d'emploi**
Programmateur d'arrosage

- I Istruzioni per l'uso**
Computer per irrigazione

- E Manual de instrucciones**
Programador de riego

- P Instruções de manejo**
Computador de rega

- GB Operating Instructions**
Water Computer

- NL Instructies voor gebruik**
Besproeiingscomputer

GARDENA Water Computer EasyControl



Translation of the original instructions from German.

Please read these operating instructions carefully and observe the notes given. Use these instructions to familiarise yourself with the Water Computer and its proper use as well as the notes on safety.



For safety reasons, children and young people under 16 as well as anyone who is not familiar with these operating instructions should not use the Water Computer. Persons with reduced physical or mental abilities may use the product only if they are supervised or instructed by a responsible person. Children must be supervised to ensure that they do not play with the product.

→ Please keep these operating instructions in a safe place.

Contents

1. Where to Use Your GARDENA Water Computer	100
2. Safety Instructions	100
3. Function	101
4. Putting Your Water Computer into Operation	104
5. Programming	107
6. Putting Your Water Computer out of Operation	111
7. Maintenance	112
8. Troubleshooting	113
9. Available Accessories	114

10. Technical Data	115
11. Service / Warranty	116

1. Where to Use Your GARDENA Water Computer

Intended use:

The GARDENA Water Computer is intended for private use in domestic and hobby gardens, exclusively for outdoor use, to control sprinklers and watering systems. The Water Computer can be used for automatic watering during holidays.

Please note:



The GARDENA Water Computer must not be used for industrial purposes or in conjunction with chemicals, foodstuffs, easily flammable and explosive materials.

2. Safety Instructions

Battery:

To ensure the Water Computer runs safely, only a 9V alkaline manganese battery (alkaline) type IEC 6LR61 must be used.

In order to stop the Water Computer from failing because of a weak battery if you are away for a long time, the battery must be replaced when the battery symbol flashes.

Setting up

The Water Computer may only be set up vertically with the sleeve nut to the top to prevent water penetrating into the battery compartment.

The minimum water output to ensure that the Water Computer functions correctly is 20 - 30 l/h.

For example, at least 10 x 2-litre Drip Heads are required to control the Micro-Drip-System.

At high temperatures (over 60 °C at the display) the LCD display may extinguish. This does not affect the program in any way. When the computer cools down the LCD display illuminates again.

The max. temperature for the water flow is 40 °C.

→ Only use clear fresh water.

The minimum operating pressure is 0.5 bar, the maximum operating pressure is 12 bar.

Avoid tensile strain.

→ Do not pull the hose connected to the Water Computer.

If the controller is removed when the valve is open, the valve remains open until the controller is fitted again.

3. Function

With the Water Computer, the garden can be watered fully automatically up to 3 times a day at any time of day (every 8 hours). Sprinklers, a sprinkler system or a drip head watering system can be used for watering.

The Water Computer carries out watering fully automatically according to the set program and can therefore also be used during holidays. Early in the morning or late in the evening, evaporation and therefore water consumption is lowest.

The watering programme is easily entered using the controls.

A watering program comprises the watering duration, cycle and start time.

Controls:

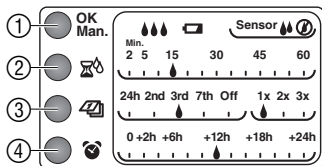

Buttons	Function
① OK-button	Applies the values set with the ---buttons.
Man.-button	For switching the water throughput on or off manually.
② - button	Changes the watering duration.
③ - button	Adjusts the watering cycle.
④ - button	Delays the watering start time.

Display

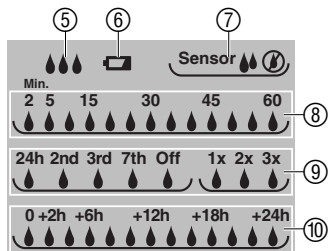

Display	Description
⑤	Flash consecutively whilst watering is carried out.
⑥	Flashes when the battery needs to be replaced. The valve is still opened for 4 weeks. Is continuously displayed when the battery is empty. The valve is not opened any more. Replace battery (see 4. Putting Your Water Computer into Operation “Insert battery”).
⑦ Sensor	Indicates that the sensor registers dry and the programmed watering is carried out.
Sensor	Indicates that the sensor registers wet and the programmed watering is not carried out (see 4. Putting Your Water Computer into Operation “Connect soil moisture or rain sensor”).
⑧	Watering duration (flashes when in input mode).
⑨	Watering cycle (flashes when in input mode).

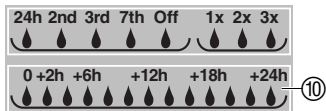

- ⑩ Start time delay (💧 flashes when in input mode).
Displays the remaining time until the program start.

4. Putting Your Water Computer into Operation

Insert battery:

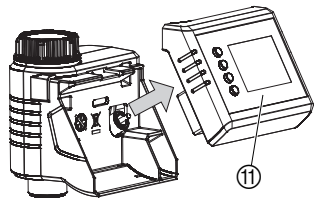

The Water Computer must only be operated with a 9 V alkali-manganese (alkaline) battery type IEC 6LR61.

1. Remove controller ⑪ from the housing of the Water Computer.
2. Insert battery in the battery compartment ⑫. **Observe correct polarity** Ⓟ.

The display shows all LCD symbols for 2 seconds and then the 💧 symbol for watering duration flashes (see 5. Programming).

3. Install controller ⑪ on the housing again.

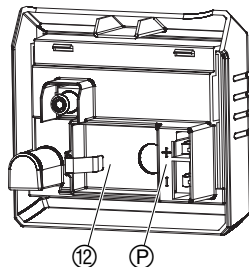

Connect Water Computer:

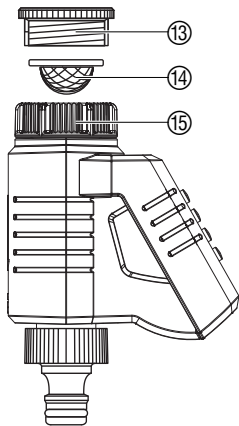

The Water Computer is fitted with a sleeve nut ⑮ for taps with (G 1") (33.3 mm) thread. The adaptor supplied ⑬ allows the Water Computer to be connected to taps with a (G 3/4") thread (26.5 mm).

→ Insert the filter ⑭ into the sleeve nut ⑮ and connect the water computer to the tap.

**Connect soil moisture
or rain sensor (optional):**

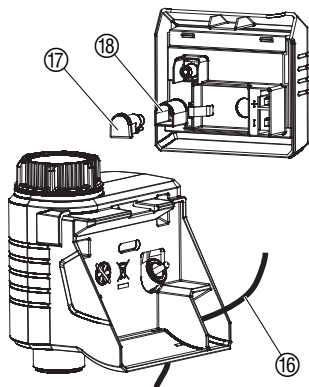

Apart from scheduled watering there is also the option of including how damp the soil is or rainfall into the watering programme.

Note:

If the soil is damp enough, the programme will be stopped, or a programme will be prevented from starting. Manual operation is possible at all times.

1. Remove controller ⑪ from the housing of the Water Computer (see 4. *Putting Your Water Computer into Operation "Insert battery"*).
2. Place soil moisture sensor **in** the watered area – **or** – place rain sensor (with extension cable if necessary) **outside** the watered area.
3. Run the sensor cable ⑯ through the opening of the housing.
4. Disconnect the cover ⑰ and insert the sensor cable ⑯ plug into the sensor connection ⑱ of the water computer.

It can take up to 1 min. until the status of the sensor is shown on the display.

An adapter cable may be required to connect older sensors, which can be purchased from GARDENA Service, **GARDENA Adapter cable Art. No. 1189-00.600.45.**

**Fit anti-theft device
(optional):**

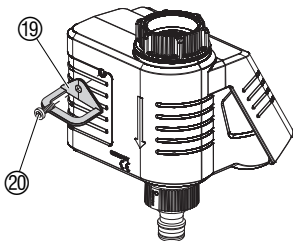

To secure your Water Computer against theft, you can obtain the **GARDENA Anti-theft device Art. No. 1815-00.791.00** from GARDENA Service.

1. Tightly screw the clamp ⑱ complete with the screw ⑳ into the circular groove on the rear of the water computer.
2. Use clamp ⑱ e.g. for fixing a chain.

It is no longer possible to remove the screw after it has been screwed in.

5. Programming

Tip: → Program the Water Computer with the tap turned off.
In this way you can avoid getting wet.

Enter watering program:

To set the programme, the controller can be removed and mobile programming can be carried out (see 4. Putting Your Water Computer into Operation “Insert battery”).

After the battery has been inserted, all program steps are automatically selected consecutively until a complete watering program has been entered.

If no program has been entered for 10 min., the watering cycle switches to “**Off**”.

Set watering duration:

The watering duration can be set between **2** to **60** minutes (at 5 minute intervals).

1. Press  button.

The  symbol flashes under the current watering duration.

2. Press  button until the desired watering duration is set (example: **30** minutes).

3. Press **OK** button.

The watering duration is stored.

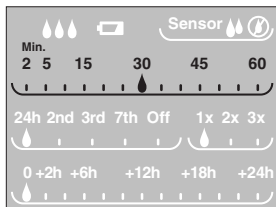

Setting the watering cycle (day / frequency):

The watering days can be set to between daily (**24h**) and every 7 days (**7th**) and the watering frequency can be set to **1x** (every 24 hours), **2x** (every 12 hours) or **3x** (every 8 hours) respectively on the watering day.

The watering program is not carried out when the knob is set to **Off**.

1. Press  button.

The  symbol flashes under the current watering days.

2. Keep pressing the  button until the desired watering days have been set (example: **2nd** = every other day).

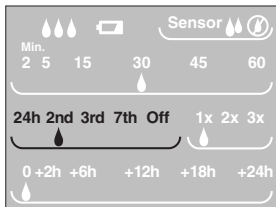

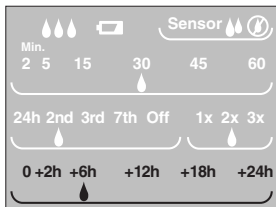
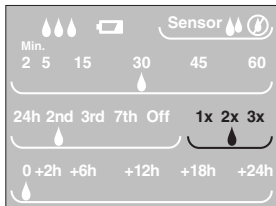

Important information :

3. Press **OK** button.

The  symbol flashes under the current watering frequency.

4. Press  button until the required watering frequency is set (example: **2x** = twice in 24 hours).

5. Press **OK** button.

The watering cycle is stored.

Setting the start time delay :

The start time can be delayed for up to 24 hours (the watering is carried out respectively at a later time). At the start time (**0**) watering is carried out immediately (the valve opens immediately).

1. Press  button.

The  symbol flashes under the current delay duration.

2. Press  button until the desired delay duration is set (example: **+6h** = Watering 6 hours later).

3. Press **OK** button.



The delay duration is stored.

If the watering days are set to off, the watering program is deactivated and neither the watering duration nor the start time delay can be modified. However, manual watering is still possible. In order to reactivate, select watering days that are not set to **off**.

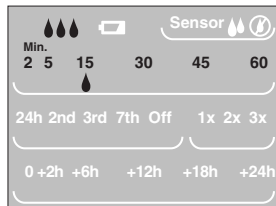
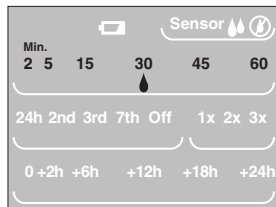
Manual watering:



The valve can be **opened or closed manually at any time**. A program-controlled open valve can also be closed early without changing the program data (Watering duration, cycle and start time). The controller must be fitted.

1. Press **Man.** button.
The  symbol flashes under the current watering duration (preset to 30 minutes at the factory) for 10 seconds on the display.
2. Whilst the water duration is flashing, it can be modified with the  button (between **2** and **60** minutes) (example: **15** minutes) and confirmed with the **OK** button.
The valve is opened.
3. Press **Man.** button to close the valve early.
The valve is closed.

The adjusted manual watering duration is saved and is independent from the watering duration in the program, i.e. the adjusted watering duration is preset for each future manual valve opening.

If the valve has been opened manually and a programmed start of watering period overlaps the manual opening period, the programmed start time is suppressed.

Example: The valve is **opened at 9.00 a.m. manually**, the opening period is 15 minutes. A program with a **start time between 9.00 and 9.15 a.m.** will not be executed in this case.

6. Putting your Water Computer out of Operation

Storage / Overwintering:



1. To preserve the battery, it should be removed (see 4. Putting Your Water Computer into Operation).

When the battery is inserted again in spring, the watering program must be newly entered again.

2. Store controller and valve unit in a dry place where they are protected from frost.

Disposal: (in accordance with RL2002/96/EC)



The product must not be added to normal household waste. It must be disposed of in line with local environmental regulations.

→ Important: Make sure that the unit is disposed of via your municipal recycling collection centre.

Disposing of flat batteries:

→ Please return flat batteries to a GARDENA dealer or dispose of them properly at your nearest recycling centre.

Only dispose of batteries when they are **flat**.

7. Maintenance

Clean filter :

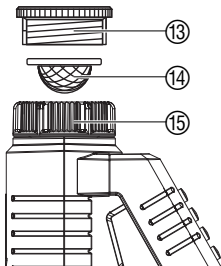

The filter ⑭ should be checked regularly and cleaned when necessary.

1. Unscrew sleeve nut ⑮ of the Water Computer by hand from the tap thread (do not use pliers).
2. If necessary unscrew the adaptor ⑬.
3. Remove filter ⑭ from sleeve nut ⑮ and clean.
4. Fit the Water Computer again (see 4. Putting Your Water Computer into Operation "Connecting Water Computer").

8. Troubleshooting

Fault	Possible Cause	Remedy
No display appears	Battery inserted incorrectly.	→ Check polarity markings match (+/-).
	Flat battery.	→ Insert new (alkaline) battery.
	Temperature on the display is higher than 60 °C.	Display appears after temperature has dropped.
Manual watering is not possible using the Man. button	Battery flat ( is continuously displayed).	→ Insert new (alkaline) battery.
	Tap turned off.	→ Turn tap on.
	Controller is not connected.	→ Mount controller on housing.
Watering program is not being undertaken (no watering)	Program entry/modification during or just before the start pulse.	→ Make program entry/ modification outside the programmed start times.
	Valve was opened manually previously.	→ Avoid possible program overlaps.
	Tap turned off.	→ Turn tap on.
	Soil moisture or rain sensor registers damp.	→ If dry, check setting/location of soil moisture/rain sensor.

Fault	Possible Cause	Remedy
Watering program is not being undertaken (no watering)	Controller is not connected.	→ Mount controller on housing.
	Battery flat ( is continuously displayed).	→ Insert new (alkaline) battery.
Water Computer does not close	Minimum quantity of water drawn is less than 20 l/h.	→ Connect more drip heads.



In the event of other faults please contact GARDENA Service. Repairs should only be carried out by GARDENA service centres or dealers authorised by GARDENA.

9. Available accessories

GARDENA Soil Moisture Sensor		Art. No. 1188
GARDENA Rain Sensor electronic		Art. No. 1189
GARDENA Anti-theft device		Art. No. 1815-00.791.00 From GARDENA Service
GARDENA Adapter cable	To connect older GARDENA sensors	Art. No. 1189-00.600.45 From GARDENA Service

GARDENA
Cable Adapter

For simultaneous connection of
rain and soil moisture sensor

Art. No. 1189-00.630.00
From **GARDENA Service**

10. Technical Data

Min./max. operating pressure: 0.5 bar / 12 bar

Operating temperature range: 5 °C to 50 °C

Flow medium: Clear fresh water

Max. liquid temperature: 40 °C

Number of program-controlled watering cycles per day: 3 x (every 8 hrs.), 2 x (every 12 hrs.), 1 x (every 24 hrs.)

Number of program-controlled watering cycles per week: Every day, every 2, 3 or 7 days

Watering duration: 2 min. to 60 min. (at 5 minute intervals)

Battery required: 1 x 9V alkaline manganese (alkaline) battery
type IEC 6LR61

Operating time of the battery: approx. 1 year

11. Service / Warranty

GARDENA guarantees this product for 2 years (from date of purchase). This guarantee covers all serious defects of the unit that can be proved to be material or manufacturing faults.

Under warranty we will either replace the unit or repair it free of charge if the following conditions apply:

- The unit must have been handled properly and in keeping with the requirements of the operating instructions.
- Neither the purchaser or a non-authorized third party have attempted to repair the unit.
- Faults which occur as a result of incorrectly installed or leaking batteries are not covered by the guarantee.
- Damage caused by frost is not covered by the warranty.

This manufacturer's guarantee does not affect the user's existing warranty claims against the dealer/seller.

If you have any problems with your Water Computer, please contact our Customer Service or return the defective unit together with a short description of the problem directly to one of the GARDENA Service Centres listed on the back of this leaflet.

D Produkthaftung

Wir weisen ausdrücklich darauf hin, dass wir nach dem Produkthaftungsgesetz nicht für durch unsere Geräte hervorgerufene Schäden einzustehen haben, sofern diese durch unsachgemäße Reparatur verursacht oder bei einem Teileaustausch nicht unsere Original GARDENA Teile oder von uns freigegebene Teile verwendet werden und die Reparatur nicht vom GARDENA Service oder dem autorisierten Fachmann durchgeführt wird. Entsprechendes gilt für Ergänzungsteile und Zubehör.

GB Product Liability

We expressly point out that, in accordance with the product liability law, we are not liable for any damage caused by our units if it is due to improper repair or if parts exchanged are not original GARDENA parts or parts approved by us, and, if the repairs were not carried out by a GARDENA Service Centre or an authorised specialist. The same applies to spare parts and accessories.

F Responsabilité

Nous vous signalons expressément que GARDENA n'est pas responsable des dommages causés par ses appareils, dans la mesure où ces dommages seraient causés suite à une réparation non conforme, dans la mesure où, lors d'un échange de pièces, les pièces d'origine GARDENA n'auraient pas été utilisées, ou si la réparation n'a pas été effectuée par le Service Après-Vente GARDENA ou l'un des Centres SAV agréés GARDENA. Ceci est également valable pour tout ajout de pièces et d'accessoires autres que ceux préconisés par GARDENA.

NL Productaansprakelijkheid

Wij wijzen er nadrukkelijk op, dat wij op grond van de wet aansprakelijkheid voor producten niet aansprakelijk zijn voor schade ontstaan door onze apparaten, indien deze door onvakkundige reparatie veroorzaakt zijn, of er bij het uitwisselen van onderdelen geen gebruik gemaakt werd van onze originele GARDENA onderdelen of door ons vrijgegeven onderdelen en de reparatie niet door de GARDENA technische dienst of de bevoegde vakman uitgevoerd werd. Ditzelfde geldt voor extra-onderdelen en accessoires.

<p>D EG-Konformitätserklärung</p> <p>Der Unterzeichnete Husqvarna AB, 561 82 Huskvarna, Sweden bestätigt, dass die nachfolgend bezeichneten Geräte in der von uns in Verkehr gebrachten Ausführung die Anforderungen der harmonisierten EU-Richtlinien, EU-Sicherheitsstandards und produktspezifischen Standards erfüllen. Bei einer nicht mit uns abgestimmten Änderung der Geräte verliert diese Erklärung ihre Gültigkeit.</p>	<p>I Dichiarazione di conformità alle norme UE</p> <p>La sottoscritta Husqvarna AB, 561 82 Huskvarna, Sweden, certifica che il prodotto qui di seguito indicato, nei modelli da noi commercializzati, è conforme alle direttive armonizzate UE nonché agli standard di sicurezza e agli standard specifici di prodotto. Qualunque modifica apportata al prodotto senza nostra specifica autorizzazione invalida la presente dichiarazione.</p>
<p>GB EU Declaration of Conformity</p> <p>The undersigned Husqvarna AB, 561 82 Huskvarna, Sweden, hereby certifies that, when leaving our factory, the units indicated below are in accordance with the harmonised EU guidelines, EU standards of safety and product specific standards. This certificate becomes void if the units are modified without our approval.</p>	<p>E Declaración de conformidad de la UE</p> <p>El que subscribe Husqvarna AB, 561 82 Huskvarna, Sweden, declara que la presente mercancía, objeto de la presente declaración, cumple con todas las normas de la UE, en lo que a normas técnicas, de homologación y de seguridad se refiere. En caso de realizar cualquier modificación en la presente mercancía sin nuestra previa autorización, esta declaración pierde su validez.</p>
<p>F Certificat de conformité aux directives européennes</p> <p>Le constructeur, soussigné : Husqvarna AB, 561 82 Huskvarna, Sweden, déclare qu'à la sortie de ses usines le matériel neuf désigné ci-dessous était conforme aux prescriptions des directives européennes énoncées ci-après et conforme aux règles de sécurité et autres règles qui lui sont applicables dans le cadre de l'Union européenne. Toute modification portée sur ce produit sans l'accord express de Husqvarna supprime la validité de ce certificat.</p>	<p>P Certificado de conformidade da UE</p> <p>Os abaixo mencionados Husqvarna AB, 561 82 Huskvarna, Sweden, por este meio certificam que ao sair da fábrica o aparelho abaixo mencionado está de acordo com as directrizes harmonizadas da UE, padrões de segurança e de produtos específicos. Este certificado ficará nulo se a unidade for modificada sem a nossa aprovação.</p>
<p>NL EU-overeenstemmingsverklaring</p> <p>Ondergetekende Husqvarna AB, 561 82 Huskvarna, Sweden, bevestigt, dat het volgende genoemde apparaat in de door ons in de handel gebrachte uitvoering voldoet aan de eis van, en in overeenstemming is met de EU-richtlijnen, de EU-veiligheidsstandaard en de voor het product specifieke standaard. Bij een niet met ons afgestemde verandering aan het apparaat verliest deze verklaring haar geldigheid.</p>	

<p>Bezeichnung des Gerätes: Bewässerungscomputer Description of the unit: Water Computer Désignation du matériel : Programmeur d'arrosage Omschrijving van het apparaat: Besproeiingscomputer Descrizione del prodotto: Computer per irrigazione Descripción de la mercancía: Programador de riego Descrição do aparelho: Computador de rega</p>	<p>Anbringungsjahr der CE-Kennzeichnung: Year of CE marking: Date d'apposition du marquage CE : Installatiejaar van de CE-aanduiding: 2013 Anno di rilascio della certificazione CE : Colocación del distintivo CE : Ano de marcação pela CE :</p>
<p>Typ: Art.-Nr.: Type: Art. No.: Type : Référence : Typ: EasyControl Art. nr.: 1881 Modello: Art. : Tipo: Art. Nº: Tipo: Art. Nº:</p>	<p>Ulm, den 19.09.2013 Ulm, 19.09.2013 Fait à Ulm, le 19.09.2013 Ulm, 19-09-2013 Ulm, 19.09.2013 Ulm, 19.09.2013 Ulm, 19.09.2013</p> <p>Der Bevollmächtigte Authorised representative Représentant légal Gemachtigde Rappresentante autorizzato Representante autorizado Representante autorizado</p>
<p>EU-Richtlinien: EU directives: Directives européennes : 2004/108/EC EU-richtlijnen: Direttive UE: 2011/65/EC Normativa UE: Directrizes da UE:</p>	<p> Reinhard Pompe (Vice President)</p>
<p>Hinterlegte Dokumentation: GARDENA Technische Dokumentation M. Kugler 89079 Ulm Deposited Documentation: GARDENA Technical Documentation M. Kugler 89079 Ulm Documentation déposée : Documentation technique GARDENA M. Kugler 89079 Ulm</p>	

Deutschland / Germany

GARDENA GmbH
Central Service
Hans-Lorenser-Straße 40
D-89079 Ulm
Produktfragen:
(+49) 731 490-123
Reparaturen:
(+49) 731 490-290
service@gardena.com

Albania

COBALT Sh.p.k.
Rr. Siri Kodra
1000 Tirana

Argentina

Husqvarna Argentina S.A.
Av.del Libertador 5954 -
Piso 11 - Torre B
(C1428ARP) Buenos Aires
Phone: (+54) 11 5194 5000
info.gardena@
ar.husqvarna.com

Armenia

Garden Land Ltd.
61 Tigran Mets
0005 Yerevan

Australia

Husqvarna Australia Pty. Ltd.
Locked Bag 5
Central Coast BC
NSW 2252
Phone: (+61) (0) 2 4352 7400
customer.service@
husqvarna.com.au

Austria / Österreich

Husqvarna Austria GmbH
Consumer Products
Industriezeile 36
4010 Linz
Tel.: (+43) 732 77 01 01 -90
consumer.service@husqvarna.at

Azerbaijan

Firm Progress
a. Aliyev Str. 26A
1052 Baku

Belgium

GARDENA Belgium NV/SA
Sterrebeekstraat 163
1930 Zaventem
Phone: (+32) 2 720 92 12
Mail: info@gardena.be

Bosnia / Hercegovina

SILK TRADE d.o.o.
Industrijska zona Bukva bb
74260 Tešanj

Brazil

Husqvarna do Brasil Ltda
Av. Francisco Matarazzo,
1400 – 19º andar
São Paulo - SP
CEP: 05001-903
Tel: 0800-112252
marketing.br.husqvarna@
husqvarna.com.br

Bulgaria

Хускварна България ЕООД
Бул. „Андрей Ляпчев“ № 72
1799 София
Тел.: (+359) 02/975 30 76
www.husqvarna.bg

Canada / USA

GARDENA Canada Ltd.
100 Summerlea Road
Brampton, Ontario L6T 4X3
Phone: (+1) 905 792 93 30
info@gardenacanada.com

Chile

Maquinarias Agroforestales
Ltda. (Maga Ltda.)
Santiago, Chile
Avda. Chesterton
8355 comuna Las Condes
Phone: (+56) 2 202 4417
Dalton@maga.cl
Zipcode: 7560330

Temuco, Chile
Avda. Valparaíso # 01466
Phone: (+56) 45 222 126
Zipcode: 4780441

China

Husqvarna (China) Machinery
Manufacturing Co., Ltd.
No. 1355, Jia Xin Rd.,
Ma Lu Zhen, Jia Ding Dist.,
Shanghai
201801
Phone: (+86) 21 59159629
Domestic Sales
www.gardena.com.cn

Colombia

Husqvarna Colombia S.A.
Calle 18 No. 68 D-31, zona
Industrial de Montevideo
Bogotá, Cundinamarca
Tel. 571 2922700 ext. 105
jairo.salazar@
husqvarna.com.co

Costa Rica

Compania Exim
Euroberoamericana S.A.
Los Colegios, Moravia,
200 metros al Sur del Colegio
Saint Francis - San José
Phone: (+506) 297 68 83
exim_euro@racsa.co.cr

Croatia

SILK ADRIA d.o.o.
Josipa Lončara 3
10090 Zagreb
Phone: (+385) 1 3794 580
silk.adria@zg.t-com.hr

Cyprus

Med Marketing
17 Digeni Akrita Ave
P.O. Box 27017
1641 Nicosia

Czech Republic

Husqvarna Česko s.r.o.
Türkova 2319/5b
149 00 Praha 4 – Chodov
Bezplatná infolinka:
800 100 425
servis@cz.husqvarna.com

Denmark

GARDENA / Husqvarna
Consumer Outdoor Products
Salgsafdeling Danmark
Box 9003
S-200 39 Malmö
info@gardena.dk

Dominican Republic

BOSQUESA, S.R.L
Carretera Santiago Licey
Km. 5 ½
Esquina Copal II.
Santiago, Dominican Republic
Phone: (+809) 736-0333
joserbosquesa@claro.net.do

Ecuador

Husqvarna Ecuador S.A.
Arupos E1-181 y 10 de Agosto
Quito, Pichincha
Tel. (+593) 22800739
francisco.jacome@
husqvarna.com.ec

Estonia

Husqvarna Eesti OÜ
Consumer Outdoor Products
Kesk tee 10, Aaviku küla
Rae vald
Harju maakond
75305 Estonia
kontakt.etj@husqvarna.ee

Finland

Oy Husqvarna Ab
Consumer Outdoor Products
Lautatarhankatu 8 B/ PL 3
00581 HELSINKI
info@gardena.fi

France

GARDENA France
Immeuble Exposial
9-11 allée des Pierres Mayettes
ZAC des Barbannières, B.P. 99
-F- 92232 GENNEVILLIERS
cedex
Tél. (+33) 01 40 85 30 40
service.consommateurs@
gardena.fr

Georgia

ALD Group
Beliasvili 8
1159 Tbilisi

Great Britain

Husqvarna UK Ltd
Preston Road
Aycliffe Industrial Park
Newton Aycliffe
County Durham
DL5 6UP
info.gardena@
husqvarna.co.uk

Greece

ΕΛΛΑΣ Α.Ε.Β.Ε.
Υπ/μα Ηφείστου 33Α
Βλ. Πλ. Κορωπίου
194 00 Κορωπί Αττικής
V.A.T. EL094094640
Phone: (+30) 210 66 20 225
info@husqvarna-consumer.gr

Hungary

Husqvarna Magyarorszag Kft.
Ezred u. 1-3
1044 Budapest
Telefon: (+36) 1 251-4161
vevoszolgalat.husqvarna@
husqvarna.hu

Iceland

Ó. Johnson & Kaaber
Tunguhalsi 1
110 Reykjavik
ooj@ojk.is

Ireland

Husqvarna UK Ltd
Preston Road
Aycliffe Industrial Park
Newton Aycliffe
County Durham
DL5 6UP
info.gardena@
husqvarna.co.uk

Italy

Husqvarna Italia S.p.A.
Via Como 72
23868 VALMADRERA (LC)
Phone: (+39) 0341.203.111
info@gardenaitalia.it

Japan

KAKUICHI Co. Ltd.
Sumitomo Realty &
Development Kojimachi
BLDG., 8F
5-1 Nibanncyo
Chiyoda-ku
Tokyo 102-0084
Phone: (+81) 33 264 4721
m_ishihara@kaku-ichi.co.jp

Kazakhstan

LAMED Ltd.
155/1, Tazhibayevoi Str.
050060 Almaty
IP Schmidt
Abayavenue 3B
110 005 Kostanay

Korea

Kyung Jin Trading CO.,LTD.
107-4, SunDuk Bld.,
YangJae-dong,
Seocho-gu,
Seoul, (zipcode: 137-891)
Phone: (+82) (0)2 574-6300

Kyrgyzstan

Alye Maki
av. Moladaya Guardir J 3
720014 Bishkek

Latvia

Husqvarna Latvija
Consumer Outdoor Products
Bākūžu iela 6
LV-1024 Rīga
info@husqvarna.lv

Lithuania

UAB Husqvarna Lietuva
Consumer Outdoor Products
Ateities pl. 77C
LT-52104 Kaunas
centras@husqvarna.lt

Luxembourg

Magasins Jules Neuberg
39, rue Jacques Stas
Luxembourg-Gasperich 2549
Case Postale No. 12
Luxembourg 2010
Phone: (+352) 40 14 01
api@neuberg.lu

Mexico

AFOSA
Av. Lopez Mateos Sur # 5019
Col. La Calma 45070
Zapopan, Jalisco
Mexico
Phone: (+52) 33 3818-3434
icornejo@afosa.com.mx

Moldova

Convel S.R.L.
290A Muncestei Str.
2002 Chisinau

Netherlands

GARDENA Nederland B.V.
Postbus 50176
1305 AD ALMERE
Phone: (+31) 36 521 00 00
info@gardena.nl

Neth. Antilles

Jonka Enterprises N.V.
Sta. Rosa Weg 196
P.O. Box 8200
Curaçao
Phone: (+599) 9 767 66 55
pgm@jonka.com

New Zealand

Husqvarna New Zealand Ltd.
PO Box 76-437
Manukau City 2241
Phone: (+64) (0) 9 9202410
support.nz@husqvarna.co.nz

Norway

GARDENA
Husqvarna Consumer
Outdoor Products
Salgskontor Norge
Klevertveien 6
1540 Vestby
info@gardena.no

Peru

Husqvarna Perú S.A.
Jr. Ramón Cárcamo 710
Lima 1
Tel: (+51) 1 3320400
ext. 416
juan.remuzgo@husqvarna.com

Poland

Husqvarna
Poland Spółka z o.o.
ul. Wysockiego 15 b
03-371 Warszawa
Phone: (+48) 22 330 96 00
gardena@husqvarna.com.pl

Portugal

Husqvarna Portugal, SA
Lagoa - Albarraque
2635 - 595 Rio de Mouro
Tel.: (+351) 21 922 85 30
Fax : (+351) 21 922 85 36
info@gardena.pt

Romania

Madex International Srl
Soseaua Odaii 117 - 123,
RO 013603
București, S 1
Phone: (+40) 21 352.76.03
madex@ines.ro

Russia

ООО „Хускварна“
141400, Московская обл.,
г. Химки,
улица Ленинградская,
владение 39, стр.6
Бизнес Центр
„Химки Бизнес Парк“,
помещение ОВ02_04

Serbia

Domel d.o.o.
Autoput za Novi Sad bb
11273 Belgrade
Phone: (+381) 1 18 48 88 12
miroslav.jejina@domel.rs

Singapore

Hy-Ray PRIVATE LIMITED
40 Jalan Pemimpin
#02-08 Tat Ann Building
Singapore 577185
Phone: (+65) 6253 2277
shiyang@hyray.com.sg

Slovak Republic

Husqvarna Česko s.r.o.
Türkova 2319/5b
149 00 Praha 4 - Chodov
Bezplatná infolinka:
800 154 044
servis@sk.husqvarna.com

Slovenia

Husqvarna Austria GmbH
Consumer Products
Industriezeile 36
4010 Linz
Tel.: (+43) 732 77 01 01-90
consumer.service@
husqvarna.at

South Africa

Husqvarna
South Africa (Pty) Ltd
Postnet Suite 250
Private Bag X6,
Cascades, 3202
South Africa
Phone: (+27) 33 846 9700
info@gardena.co.za

Spain

Husqvarna España S.A.
C/ Basauri, nº 6
La Florida
28023 Madrid
Phone: (+34) 91 708 05 00
atencioncliente@gardena.es

Suriname

Agrofix n.v.
Verlengde Hogestraat # 22
Phone: (+597) 472426
agrofix@sr.net
Pobox : 2006
Paramaribo
Suriname-South America

Sweden

Husqvarna AB
S-561 82 Huskvarna
info@gardena.se

Switzerland / Schweiz

Husqvarna Schweiz AG
Consumer Products
Industriestrasse 10
5506 Mägenwil
Phone: (+41) (0) 848 800 464
info@gardena.ch

Turkey

GARDENA Dost Diş Ticaret
Mümesillik A.Ş.
Sanayi Çad. Adil Sokak
No: 1/B Kartal
34873 Istanbul
Phone: (+90) 216 38 93 939
info@gardena-dost.com.tr

Ukraine / Україна

ТОВ «Хусварна Україна»
вул. Васильківська, 34,
офіс 204-р
03022, Київ
Тел. (+38) 044 498 39 02
info@gardena.ua

Uruguay

FELI SA
Entre Rios 1083 CP 11800
Montevideo - Uruguay
Tel: (+598) 22 03 18 44
info@felisa.com.uy

Venezuela

Corporación Casa y Jardín C.A.
Av. Caroní, Edif. Trezmen, PB.
Colinas de Bello Monte.
1050 Caracas.
Tlf: (+58) 212 992 33 22
info@casayjardin.net.ve

1881-20.960.02/1113
© GARDENA
Manufacturing GmbH
D-89070 Ulm
http://www.gardena.com